

Barrier-free thresholds for front doors, window and lifting-sliding doors with reliable protection against moisture damage

Integrated surface drainage system heroal DS

heroal

Drainage system

First-class materials, technical perfection down to the smallest detail and a wide variety of design options are the unique characteristics of heroal's efficient system technology. Advantages that are convincing. For decades, heroal has been the reliable partner for architects, builders and fabricators, offering innovative solutions for the building shell made from aluminium and aluminium composites.

Planners appreciate the wide range of versatile design options, builders are able to create individual requirements with a reliable system, and our partners benefit from economically efficient heroal system solutions.

The drainage system heroal DS has been developed in order to implement barrier-free thresholds for entrance doors, French and lifting-sliding doors and at the same time protect the interior against damages due to moisture. This reliable solution ensures that surface water drains off without any backflow. It complies with the German standards DIN 18040-1 and DIN 18040-2, referring to barrier-free construction.

Explore the integrated linear surface drainage system heroal DS!



heroal DS

Integrated linear surface drainage system

Page 4

heroal DS

Accessible thresholds and protection against moisture damages

Page 5

heroal DS for heroal door systems

System solution with zero-barrier

Page 6

heroal DS for heroal window systems

Accessible system solution

Page 8

heroal DS for heroal lifting-sliding systems

Accessible system solution for large openings

Page 10

heroal DS

Integrated linear surface drainage system

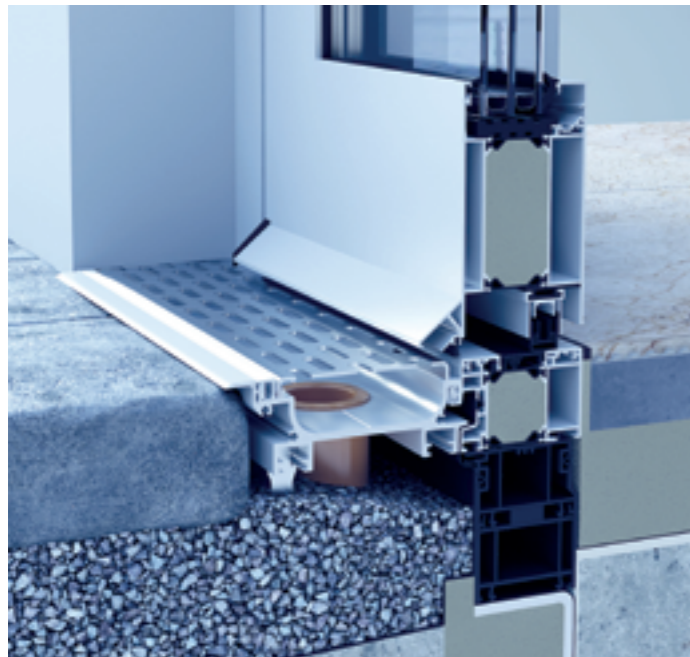

Special steps are necessary in order to create fully accessible thresholds that also protect the inside against moisture damages. A reliable solution is the integration of a drainage system that makes sure that any surface water is discharged without backing up. When planning a surface drainage for an effective discharge of water, it is important to consider the average rainfall and the quality of the surface outside in order to choose the perfect drainage.

The innovative drainage system heroal DS provides builders, planners and architects with planning reliability, versatile options for combinations and system solutions meeting the needs of different trades.

- » solutions for all large openings designed as entrance doors, French doors and lifting-sliding doors
- » a wide range of combinations of heroal systems ensures planning reliability
- » easy integration into the building structure, whether newbuild or renovation
- » discharge of surface water without backing-up
- » discharge capacity of approx. 0.8 l/s with standard DN 50
- » support feet for loads of up to 1.5 t at a given point, for individual positioning
- » high-grade stainless steel cover in different designs

System components of drainage system

1. drainage profile
2. stainless steel drainage grid
3. end cap of drainage profile
4. cover profile
5. adjustable feet
6. 3-part screw fitting, DN 50
7. 87° pipe bend, DN 50
8. EPDM-sealing sheets

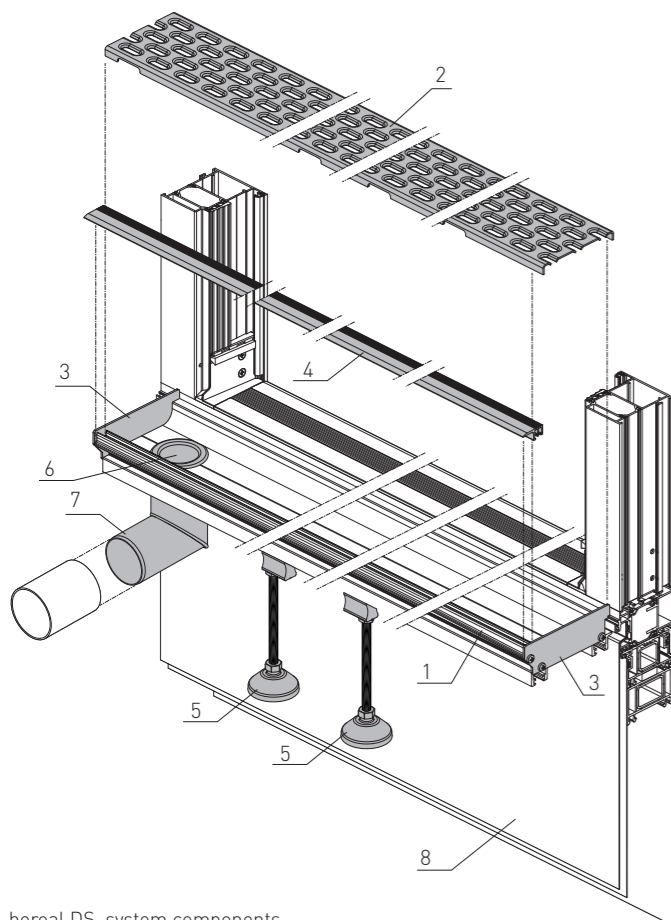

heroal DS, system components

heroal DS

Accessible thresholds and protection against moisture damages

Statutory provisions and legal requirements

The German Industry Norms DIN 18040-1 for publicly accessible buildings and DIN 18040-2 for accessible dwellings expressly claim that thresholds shall not represent any impediment in any way. In exceptional cases, where there is no other option, a maximum design height of 20 mm is allowed, though. The German legislative body supports these norms by an amendment to the credit programme 159, „age-based conversion“ of the KfW banking group, and supports accessible entrance doors for houses and flats, based on DIN 18040-2 for one- and two-family houses and flats.

Zero-barriers make sure that entrance elements can be crossed easily, i.e. without limitations due to threshold variants that may be technically necessary in order to ensure the general tightness of the element.

Drainage system heroal DS

heroal offers solutions for all large openings in the fields of entrance doors, French doors and lifting-sliding doors. These are compatible with other heroal systems and meet legal requirements.

The drainage system heroal DS represents the perfect innovative solution to create accessible thresholds while at the same time protecting the inside against moisture damages. State-of-the-art base and connecting profiles to ensure a proper sealing of the connection to the bottom of the building structure are at the core of this innovation, since they provide for the connection of the linear drainage system.

This drainage system returns the accumulating surface water at a capacity of up to 0.8 l/s without backing-up, covered by a high-grade stainless steel grid. Clampable base and connecting profiles at the bottom connection of the opening elements provide for the fixing of sealing sheets ensuring the protection of the building structure. Regardless of the opening type, the innovative drainage system heroal DS is the ideal solution for all large openings - whether for newbuilds or renovation.

The compatibility of heroal systems ensures that the drainage system can be used for a variety of systems in the fields of windows, doors and lifting-sliding elements. The drainage system heroal DS is classified as an accompanying measure acc. to RAL and the German Industry Norm DIN 18198-9. It is not classified as a drainage system to be used for buildings or building surfaces acc. to German Industry Norm DIN 1986-100 and DIN EN 12056.

In order to drain the building /building surfaces and paved surfaces in front of the elements, it is necessary to install additional appropriate surface drainage systems. Any adjoining surfaces have to slope away from the opening elements installed in the building. Depending on the individual place of installation of the element, additional steps (e.g. a canopy) may be necessary to protect the building against penetrating water.

Installation, maintenance and care

Further structural measures required for additional surface drainage and the connection of the drainage to any planned or existing rainwater system including backflow trap are to be discussed with the other trades involved and agreed in advance with the tendering bodies.

heroal drainage system is made of high-grade aluminium and stainless steel. These materials stand out for their high resistance against corrosion and acids.

Regular cleaning and care is recommended in order to maintain the aesthetic appearance of the heroal drainage system for a long time. Highly frequented areas require maintenance intervals of 3-6 months, less frequented areas intervals of 6-12 months..

heroal DS for heroal D 72

System solution with zero-barrier



System features

- » accessible or zero-barrier system solutions acc. to German Industry Norm DIN 18040
- » free passing through large entrances - without limitations
- » available with all-around sash frame or with base profile, inward or outward opening, regardless of opening type
- » retractable door seal at the bottom ensures perfect tightness
- » easy integration into the building structure, whether newbuild or renovation
- » minimal installation height = 46 mm, isolated flow depth = 140 mm, discharge capacity approx. 0.8 l/s with a standard DN 50
- » compatible with the door systems:
 - heroal D 72
 - heroal D 72 RL
 - heroal D 72 CL

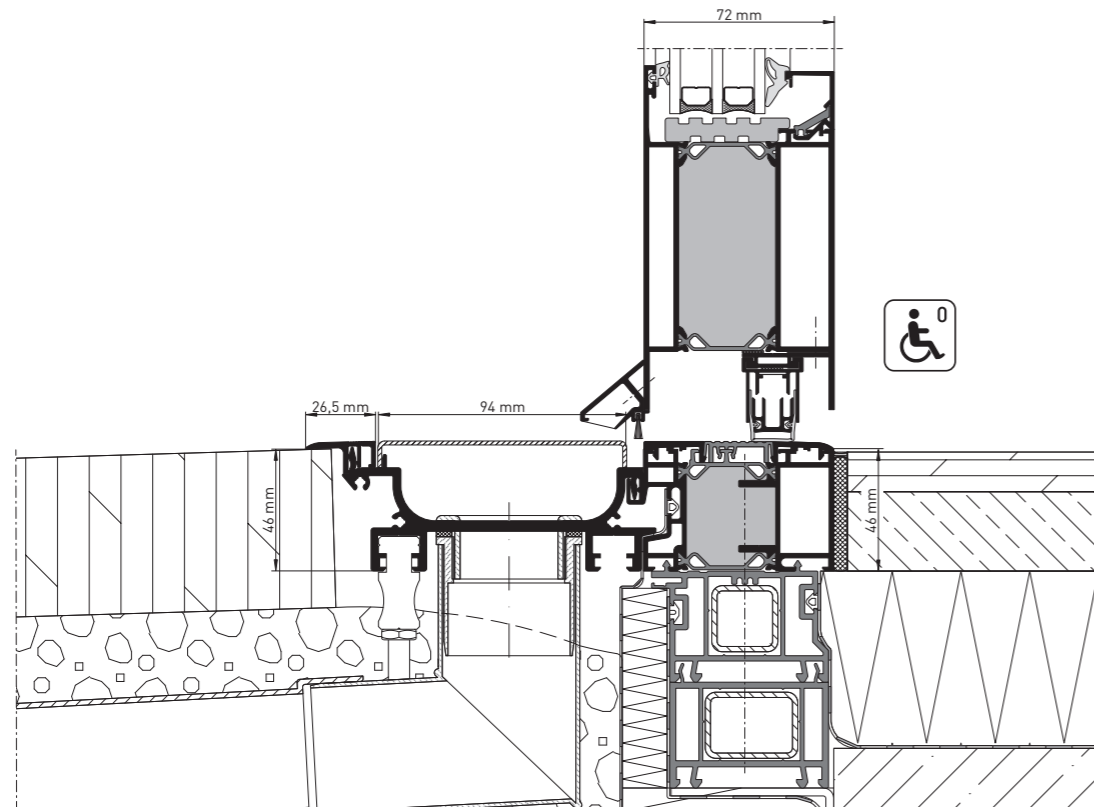
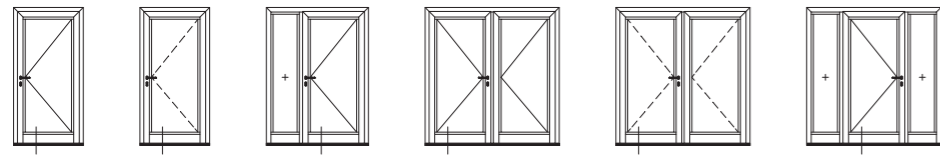

heroal D 72 with heroal DS, cross section

heroal DS for heroal D 92 UD

System solution with zero-barrier



System features

- » accessible system solutions acc. to German Industry Norm DIN 18040
- » free passing through large entrances - without limitations
- » all-around sealing levels in element and sash frames ensure perfect tightness
- » easy integration into the building structure, whether newbuild or renovation
- » minimal installation height = 46 mm, isolated flow depth = 140 mm, discharge capacity approx. 0.8 l/s with a standard DN 50
- » compatible with the door system: heroal D 92 UD

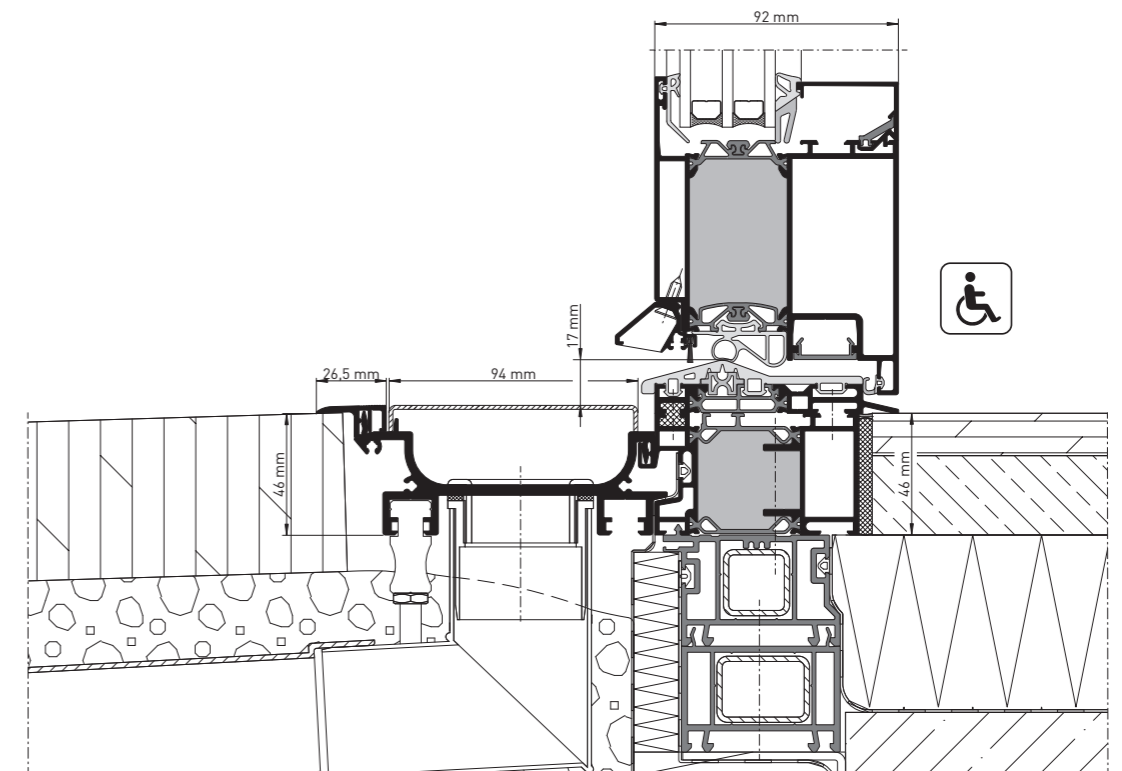
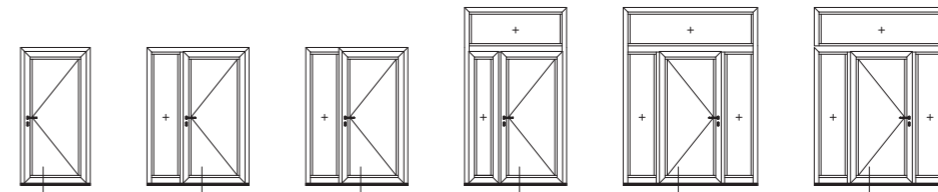

heroal D 92 UD with heroal DS, cross section

heroal DS for heroal W 72

Accessible system solution



System features

- » accessible system solutions acc. to German Industry Norm DIN 18040
- » free passing through large window elements without limitations
- » available in combination with inward opening Tilt-turn (DK), Tilt (D) and French elements, regardless of opening type
- » all-around sealing levels in element and sash frames ensure perfect tightness
- » easy integration into the building structure, whether newbuild or renovation
- » minimal installation height = 46 mm, isolated flow depth = 140 mm, discharge capacity approx. 0.8 l/s with a standard DN 50
- » compatible with the window systems:
 - heroal W 72
 - heroal W 72 RL
 - heroal W 72 CL
 - heroal W 72 i

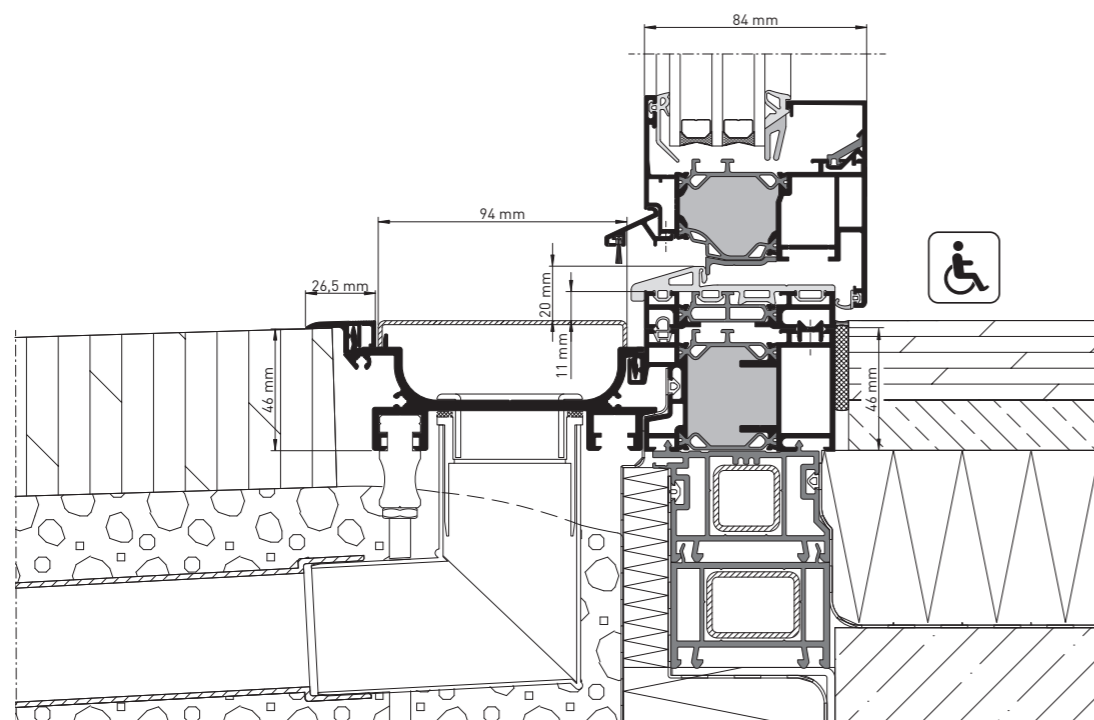
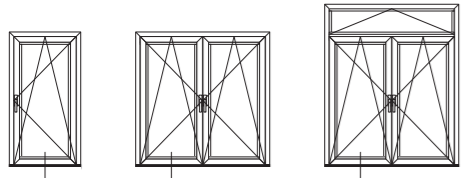

heroal W 72 with heroal DS, cross section

heroal DS for heroal W 77

Accessible system solution



System features

- » accessible system solutions acc. to German Industry Norm DIN 18040
- » free passing through large window elements without limitations
- » available in combination with inward opening Tilt-turn (DK), Tilt (D) and French elements, regardless of opening type
- » all-around sealing levels in element and sash frames ensure perfect tightness
- » easy integration into the building structure, whether newbuild or renovation
- » minimal installation height = 46 mm, isolated flow depth = 140 mm, discharge capacity approx. 0.8 l/s with a standard DN 50
- » compatible with the window systems:
 - heroal W 77
 - heroal W 77 i

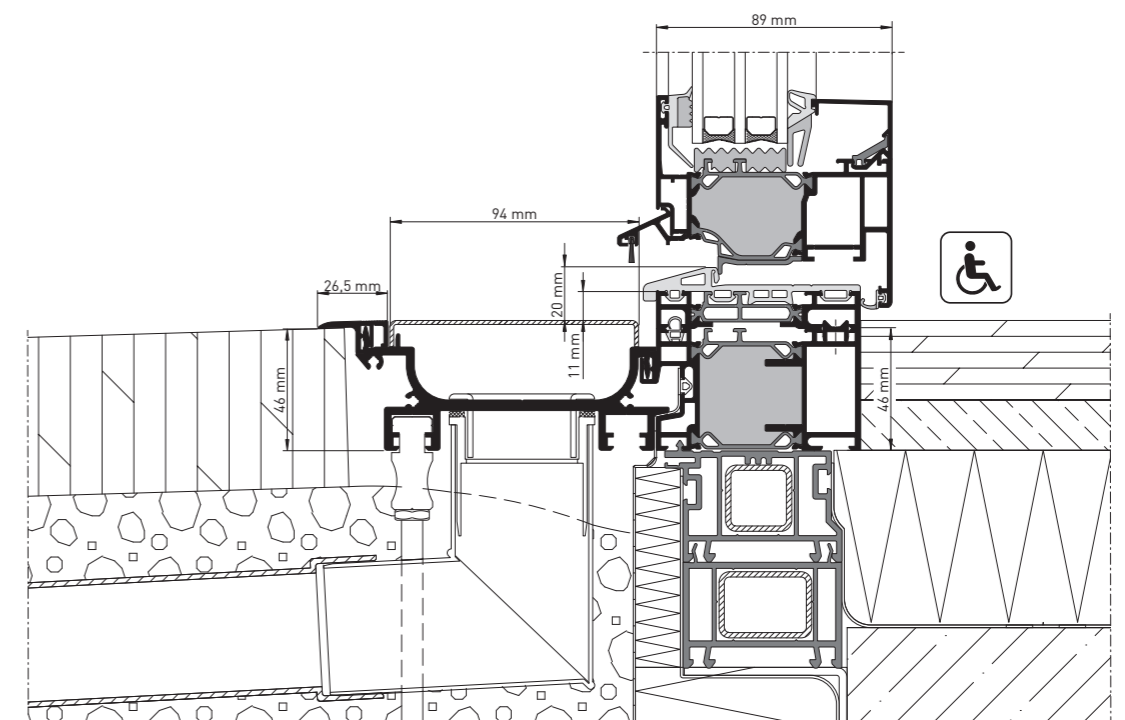
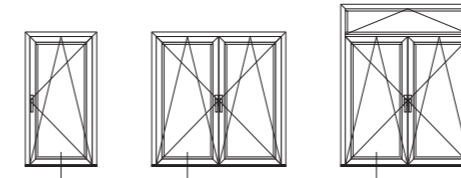

heroal W 77 with heroal DS, cross section

heroal DS for heroal S 77

Accessible system solution for large openings



System features

- » accessible system solutions acc. to German Industry Norm DIN 18040
- » free passing through large lifting-sliding elements without limitations
- » available in combination with two- or three-track lifting-sliding elements, regardless of opening type
- » all-around sealing levels in element and sash frames ensure perfect tightness
- » easy integration into the building structure, whether newbuild or renovation
- » minimal installation height = 92 mm, isolated flow depth = 140 mm, discharge capacity approx. 0.8 l/s with a standard DN 50
- » compatible with the lifting-sliding systems:
 - heroal S 77
 - heroal S 77 SC
 - heroal S 77 HI

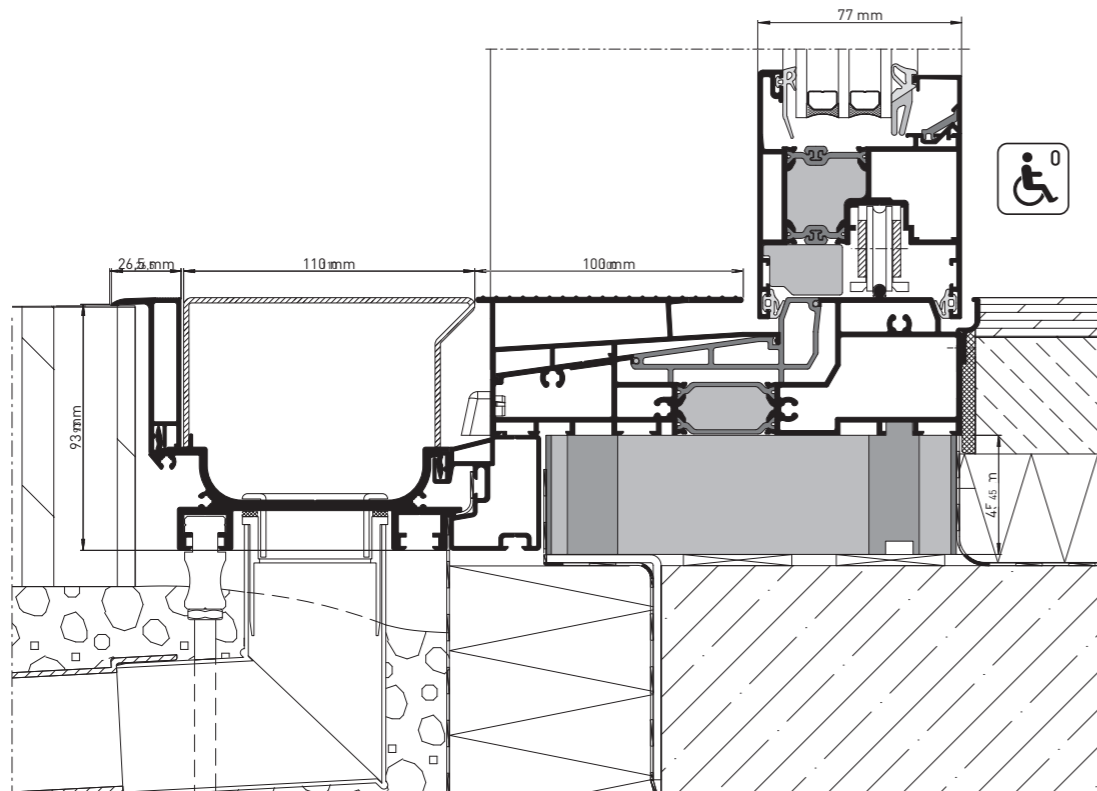
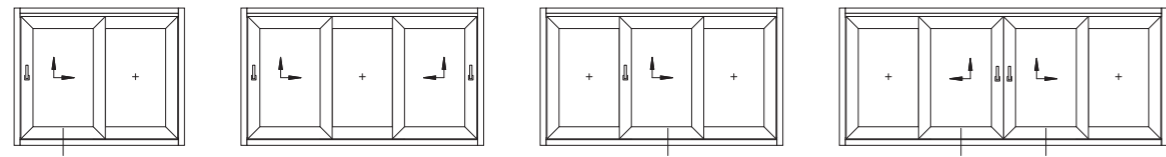

heroal S 77 with heroal DS, accessible acc. to German Industry Norm DIN 18040, cross section

heroal DS for heroal S 77 SL

Accessible system solution for large openings



System features

- » accessible system solutions acc. to German Industry Norm DIN 18040
- » free passing through large lifting-sliding elements without limitations
- » available in combination with lifting-sliding elements with one or two sashes with monorail, regardless of opening type
- » all-around sealing levels in element and sash frames ensure perfect tightness
- » easy integration into the building structure, whether newbuild or renovation
- » minimal installation height = 80 mm, isolated flow depth = 140 mm, discharge capacity approx. 0.8 l/s with a standard DN 50
- » compatible with the lifting-sliding systems:
 - heroal S 77 SL/SC
 - heroal S 77 SL
 - heroal S 77 SL/HI
 - heroal S 77 SL/CC

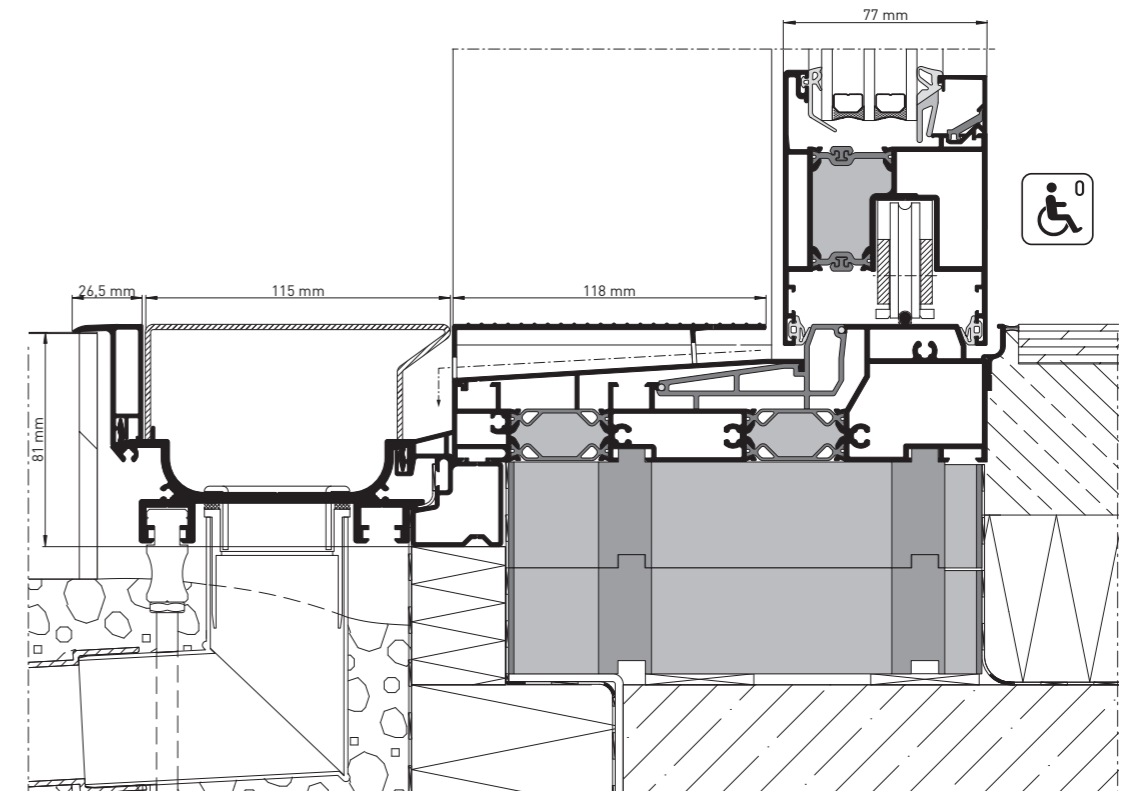
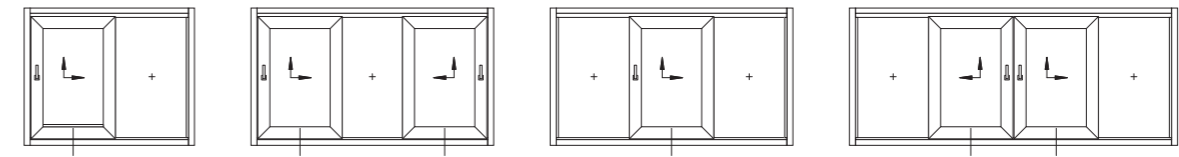

heroal S 77 with heroal DS, accessible acc. to German Industry Norm DIN 18040, cross section

heroal



simply better *spaces for life*

As a manufacturer of aluminium system solutions for roller shutters, sun protection, roller doors, windows, doors, sliding doors, curtain walls and patio roofs, heroal is an international market leader, supporting high-quality residential and commercial construction projects worldwide. heroal products are developed and manufactured in Germany and set themselves apart with their premium quality and exceptional performance features. As a result, the innovative system solutions contribute to greater sustainability, security, comfort and architectural freedom for both current and future building projects and impress with simple and efficient planning and fabrication by heroal specialist partners.

Roller shutters | Sun protection | Roller doors | Windows | Doors | Sliding doors | Curtain walls | Patio roofs

heroal – Johann Henkenjohann GmbH & Co. KG

Österwieher Str. 80 | 33415 Verl (Germany) | Tel. +49 5246 507-0 | Fax +49 5246 507-222 | www.heroal.com

Item no. 88134 30 01 | 06.2024